



PORTE SEZIONALI

by **RYTERNA**







Content:

8	DOGA PICCOLA
10	DOGA MEDIA
12	DOGA INTERA
14	CASSETTONE
16	SLICK
20	SLICK PLUS
22	MACRORIB & MICRORIB
24	TOPRIB
26	SLIM LINE
28	OKOUME
30	ALUMAX
32	RETRO
34	PORTE DOPPIA ANTA
40	PORTE PEDONALI LATERALI
44	PORTA PEDONALE INTEGRATA
46	APPLICAZIONI
48	SEZIONI FINESTRATE
49	FINESTRE IN ACCIAIO
49	PVC DOUBLE GLAZED WINDOWS
51	MECCANICA R40
53	MECCANICA TL
55	ACCESSORI
56	PORTA SEZIONALE A SCORRIMENTO LATERALE



Porta sezionale in Okoume.
Portoncino d'ingresso RD65 Design 109 Golden Oak.



Creatività illimitata

Con le nostre porte vivrai la libertà di esprimere le tue idee in ogni modo.



Porta Sezionale TL Slick RAL 7016 con design personalizzato.
Portoncino d'Ingresso RD80 Design 220.



Look e funzionalità

Linee tese e forme squadrate per uno stile minimalista. O più semplicemente la soluzione più efficace per chiudere i tuoi spazi.



Doga piccola



Doghe orizzontali da 10 cm per una porta semplice e robusta dal look senza tempo. La soluzione più flessibile per ogni tipo di architettura.

La porta con pannello Doga Piccola è la soluzione più indicata per le porte di grande dimensioni. Fino a 10 metri di larghezza.



Verniciature simil-RAL
disponibili a richiesta.



Legno



Stucco



RAL 9016



RAL 8017

Meccanica R40 MS/ML/TM e TL STD/LHR FM/LHR RM



Doga media



La porta con pannello doga media è caratterizzata da una nervatura centrale su ogni pannello. I pannelli doga media sono disponibili nelle versioni gofrato legno, stucco o liscio. Nelle versioni lisce, lo spessore doppio della lamiera esterna garantisce la perfetta planarità del pannello.



Verniciature simil-RAL
disponibili a richiesta.



Liscio doppio
spessore



Legno



Stucco



Light Oak
liscio



Golden Oak
liscio



Old Oak
liscio



Dark Oak
liscio



Mahogany
liscio



Winchester
liscio

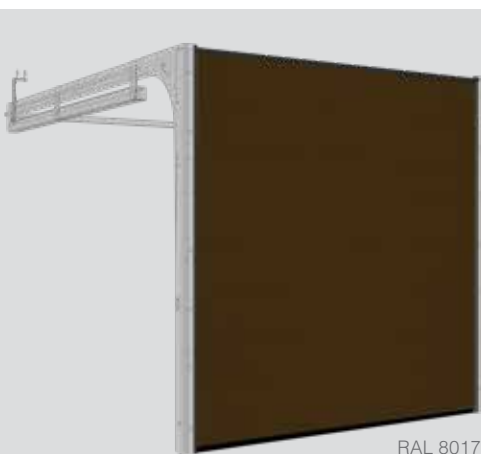

RAL 8017

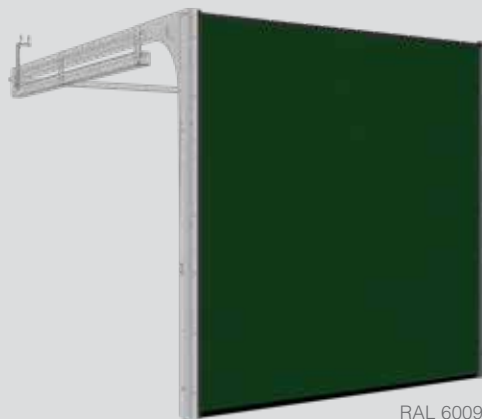

RAL 6009

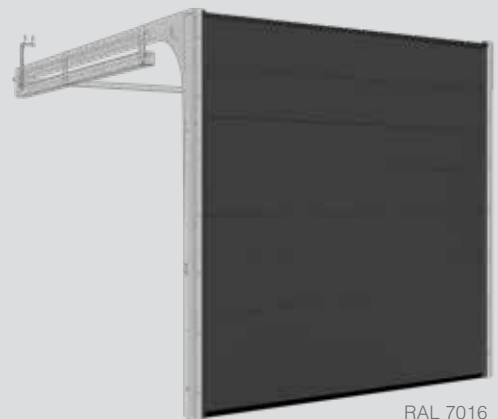

RAL 7016

Meccanica R40 MS/ML/TM e TL STD/LHR FM/LHR RM



Doga intera

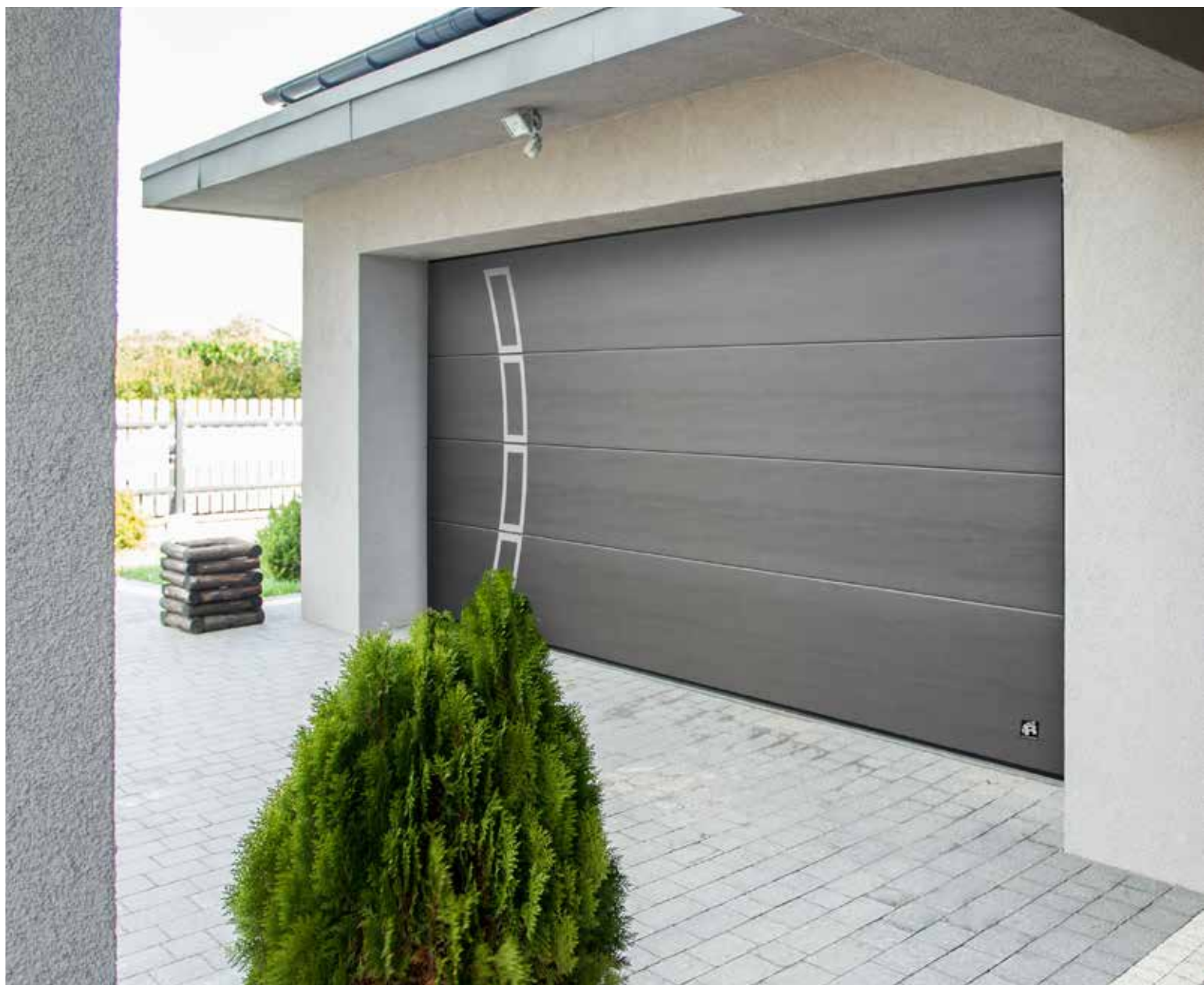

La porta con pannello doga intera con i suoi pannelli interi gofrato legno o stucco, offre un look che unisce lo stile antico a quello moderno, il look snello ma sobrio crea un grande effetto quando abbinato alle finestre con cornice in acciaio spazzolato.



Verniciature simil-RAL
disponibili a richiesta.



Legno



Stucco



RAL 9016

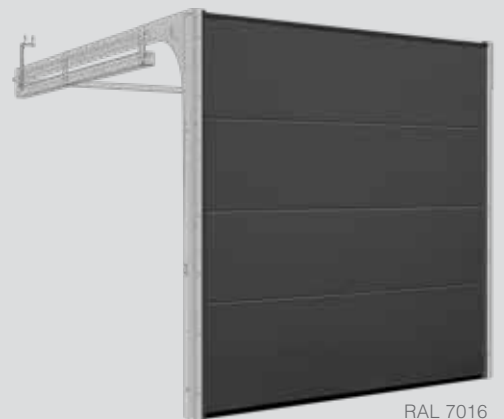

RAL 7016

Meccanica R40 MS/ML/TM e TL STD/LHR FM/LHR RM



Cassettone



La pannellatura a cassettoni ha il tipico stile georgiano caratterizzato da pannelli scolpiti tridimensionalmente sulla superficie esterna. La porta cassettone è usata soprattutto su case con stile tradizionale o country.



Verniciature simil-RAL
disponibili a richiesta.



RAL 9016
legno



Golden Oak
legno



RAL 9016



RAL 8017

Meccanica R40 MS/ML/TM e TL STD/LHR FM/LHR RM



Slick



Il pannello top di gamma. Lo spessore doppio della lamiera garantisce la massima planarità e resistenza strutturale. Un look indiscutibilmente solido per una resa estetica di massimo livello. Questa porta si inserisce nello stile di qualsiasi edificio. La superficie liscia è perfetta per essere associata a finestre con cornice in acciaio spazzolato e per qualsiasi tipo di applicazione.



RAL 9016



Verniciature simil-RAL. Colori perlato RAL disponibili a richiesta.

Liscio doppio spessore

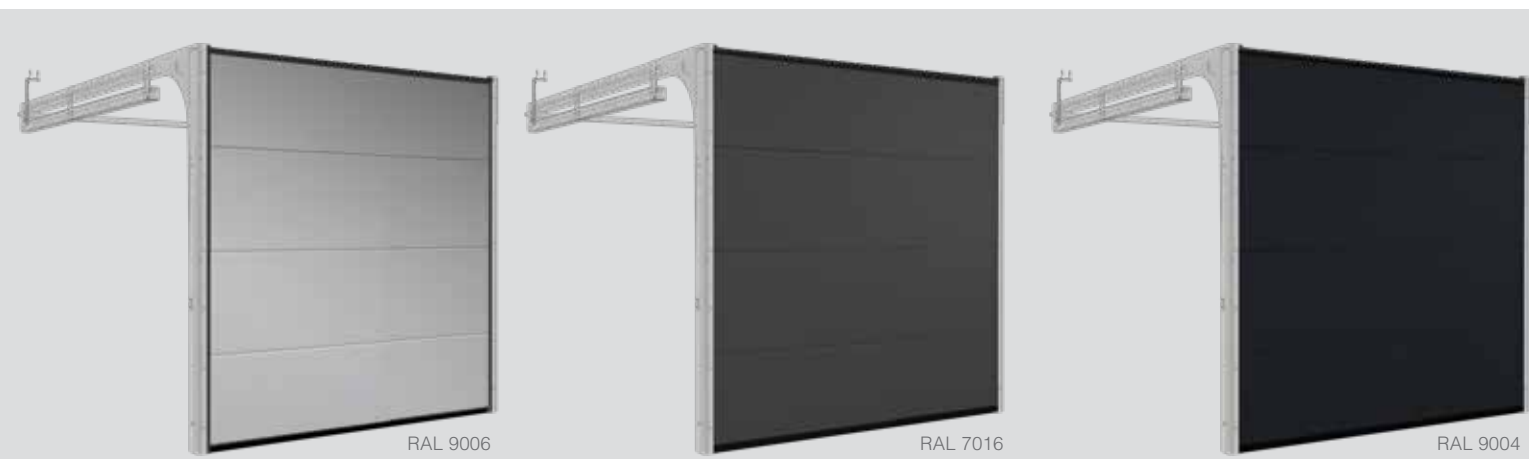

Meccanica R40 MS/ML/TM e TL STD/LHR FM/LHR RM

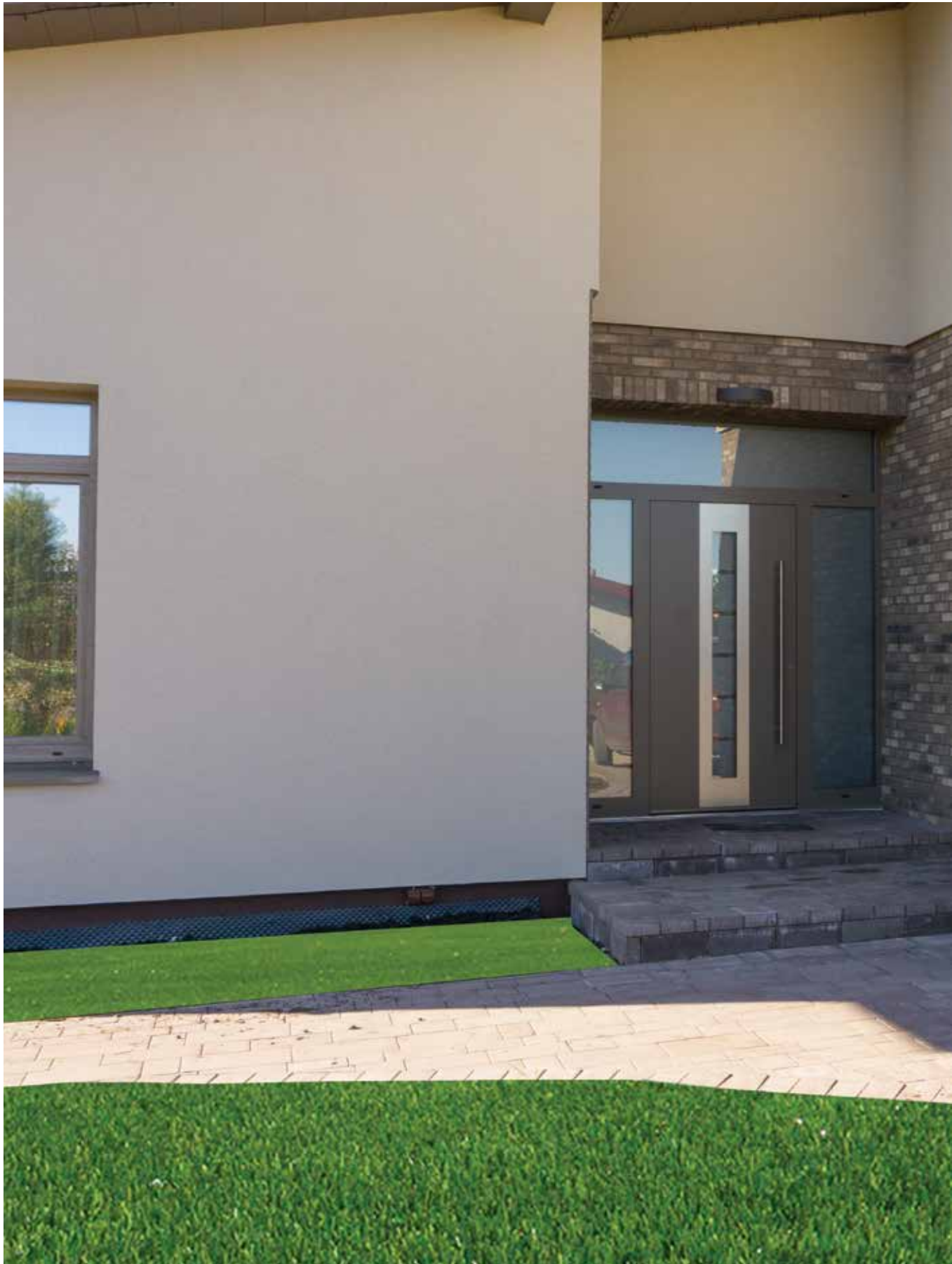

Porta Sezionale TL Slick Design personalizzato.



Associare il portoncino di ingresso al sezionale non è mai stato così facile.



Slick Plus



Effetto Acciaio



Antracite Grigio



Simil Ruggine

Finitura esclusiva con superficie liscia



3D Grigio

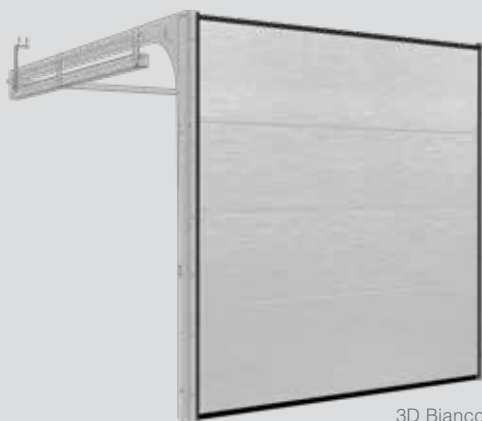

3D Bianco



Gessato Grigio

Meccanica R40 MS/ML/TM e TL STD/LHR FM/LHR RM



Macrorib & Microrib



La superficie della porta MACRORIB è gofrata con leggere ondulazioni con passo da 20 mm. Una porta estremamente robusta dall'aspetto piacevole.

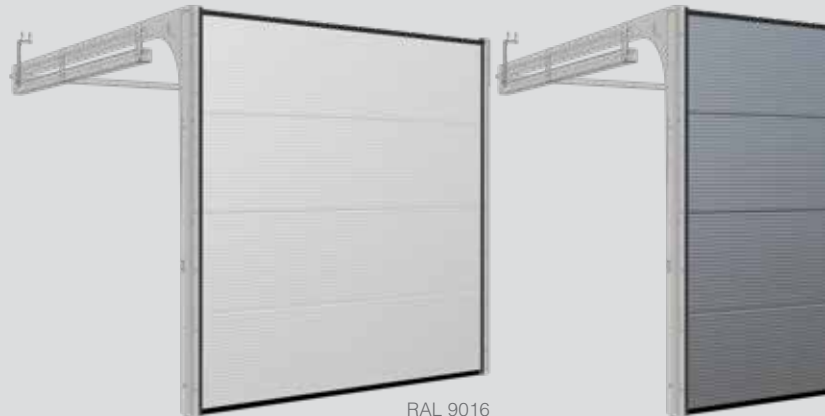

RAL 9016



Verniciature simil-RAL disponibili a richiesta.



Finitura stucco macrodoga 10 mm



RAL 9016

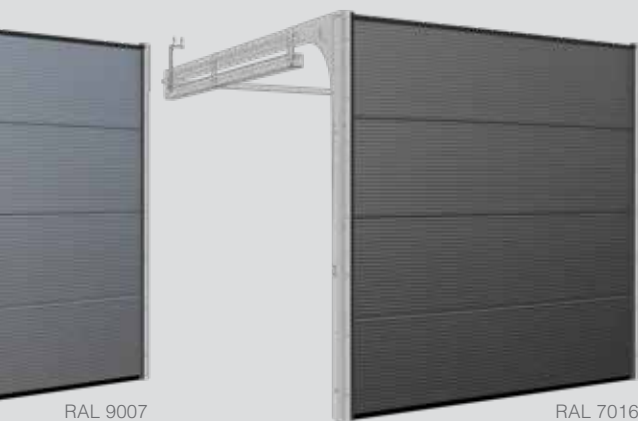

RAL 9007

RAL 7016

Meccanica R40 MS/ML/TM e TL STD/LHR FM/LHR RM

La soluzione migliore che coniuga design e solidità. Una porta robusta che ben si addice all'applicazione di finestre in acciaio satinato. Il pannello MICRORIB è caratterizzato da leggere ondulazioni con passo di 10 mm. Disponibili nella colorazione RAL 9016 ed a richiesta in tutti gli altri colori.



Finitura liscia
microdoga 10 mm



TopRib

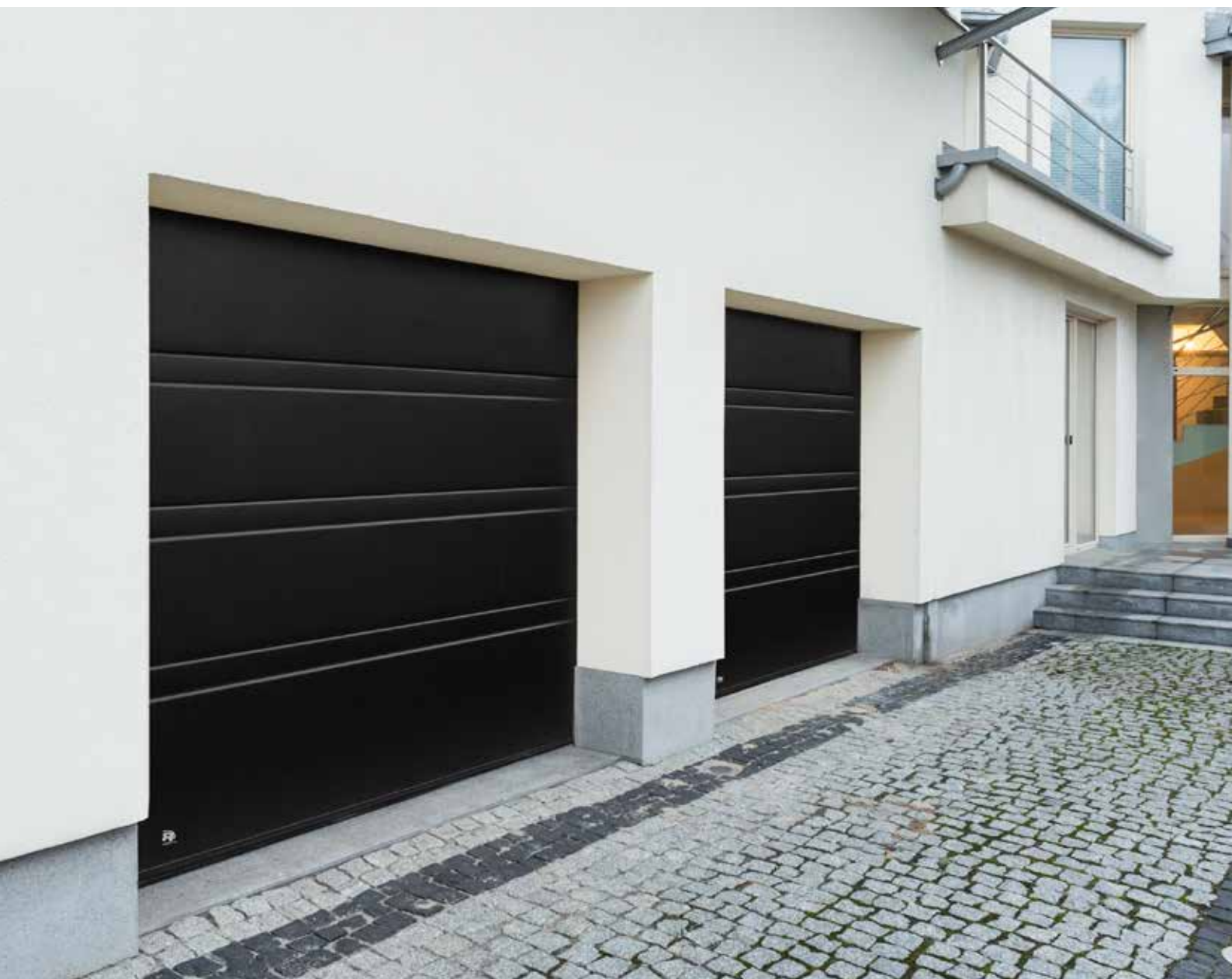

Un'altra interpretazione di grande livello: il manto TOPRIB. La doppia scanalatura a passo differenziato è una delle soluzioni più richieste nel mercato del design. Lo spessore doppio della lamiera esterna garantisce la perfetta planarità del pannello.



Verniciature simil-RAL
disponibili a richiesta. Colori perlati RAL
disponibili a richiesta.

Liscio doppio
spessore



RAL 9016

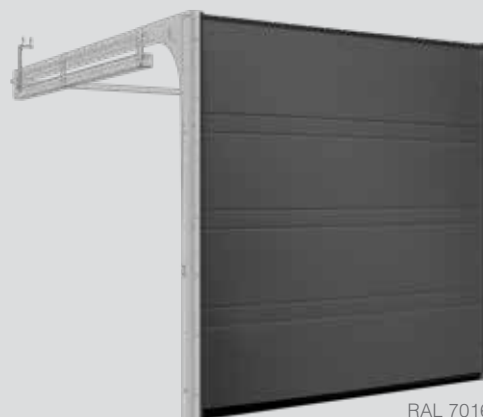

RAL 7016

Meccanica R40 MS/ML/TM e TL STD/LHR FM/LHR RM



Slim Line

Design moderni, applicazioni in alluminio, finestre di vario tipo, una gamma infinita di colori. Molteplici soluzioni per armonizzare il portone al design della tua casa. Senza rinunciare alla qualità delle nostre porte.







Okoume





Pannello coibentato rivestito da uno strato di OKOUME trattato da 12 o 18 mm a seconda della lavorazione. Oltre a Design prestabiliti è possibile realizzare qualsiasi lavorazione personalizzata.





Alumax



Porta sezionale ALUMAX design a scelta
armonizzata con portoncino d'ingresso RD80.



Stesso materiale per il sezionale ed il portoncino di ingresso. Abbinabile ai portoncini RD80/100. I pannelli coibentati del sezionale vengono rivestiti con una lastra di alluminio da 2,5 mm che garantisce la stessa finitura del portoncino d'ingresso. Design personalizzato.





Retro

Ricreiamo le vecchie porte in stile Country.
Realizzabile anche con design specifico.



Retro S



Retro X



Retro H







Porte Doppia Anta

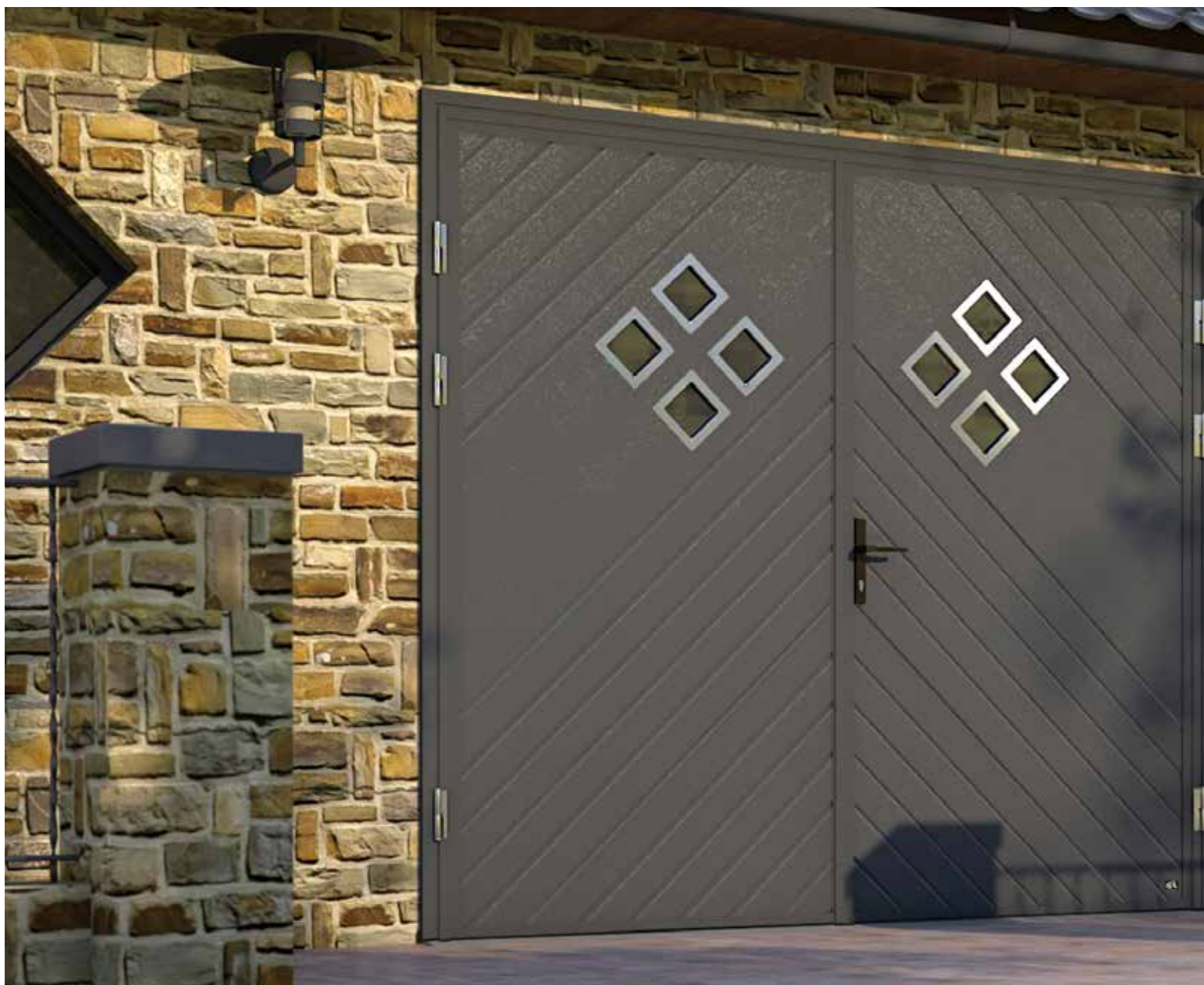

Isolata e robusta! Sono disponibili tutti i design, le tipologie pannelli e i colori RAL. Potrai scegliere vari accesorii tra cui finestre, sezione finestrate, applicazioni in acciaio, o portina per animali. Le ante delle porte laterali a doppia anta possono essere fornite simmetriche o asimmetriche, e la maniglia può essere posizionata sull'anta di destra o di sinistra a seconda delle preferenze. I colori standard delle maniglie sono nero, bianco o alluminio. Disponibili in altri colori come opzionale aggiuntivo.

Porte su misura con larghezza massima di 3 metri e altezza massima di 2,4 metri.



Verniciature simil-RAL
disponibili a richiesta.



Liscio doppio
spessore



Legno



Stucco







Chiusura a spagnoletta



Apriporta



Rostrì



Rivestimento soglia
S5 in acciaio satinato





Porta Doppia Anta SH2 SLICK RAL 9007 con doghe verticali.





Porte pedonali laterali



Produciamo porte pedonali che si combinano a qualsiasi modello di porta sezionale residenziale.

Le porte pedonali laterali sono prodotte con pannelli coibentati da 40 mm di spessore con poliuretano espanso senza CFC. La struttura della porta è costituita da profili in alluminio e guarnizioni di tenuta perimetrali. I pannelli e le finestre delle porte pedonali laterali sono allineati ai pannelli ed alle finestre delle porte sezionali.

Porte con doppio manto sono disponibili su richiesta.



Senza cornici



Con cornici



Installazione semplificata

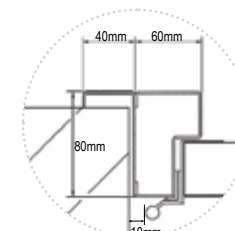

Dimensioni del telaio



Colori standard delle maniglie: argento, nero, bianco. Altri colori a richiesta.



Rostrì di sicurezza







Porta Pedonale Integrata



La soluzione ideale quanto è richiesta un'entrata aggiuntiva e non c'è spazio per realizzare una porta pedonale. Le porte pedonali integrate sono fornite con chiudiporta. Si può scegliere tra porta con soglia tradizionale oppure con soglia ribassata. Quest'ultima ideale per il passaggio con biciclette o mezzi con ruote.

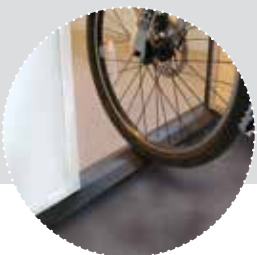

Soglia ribassata



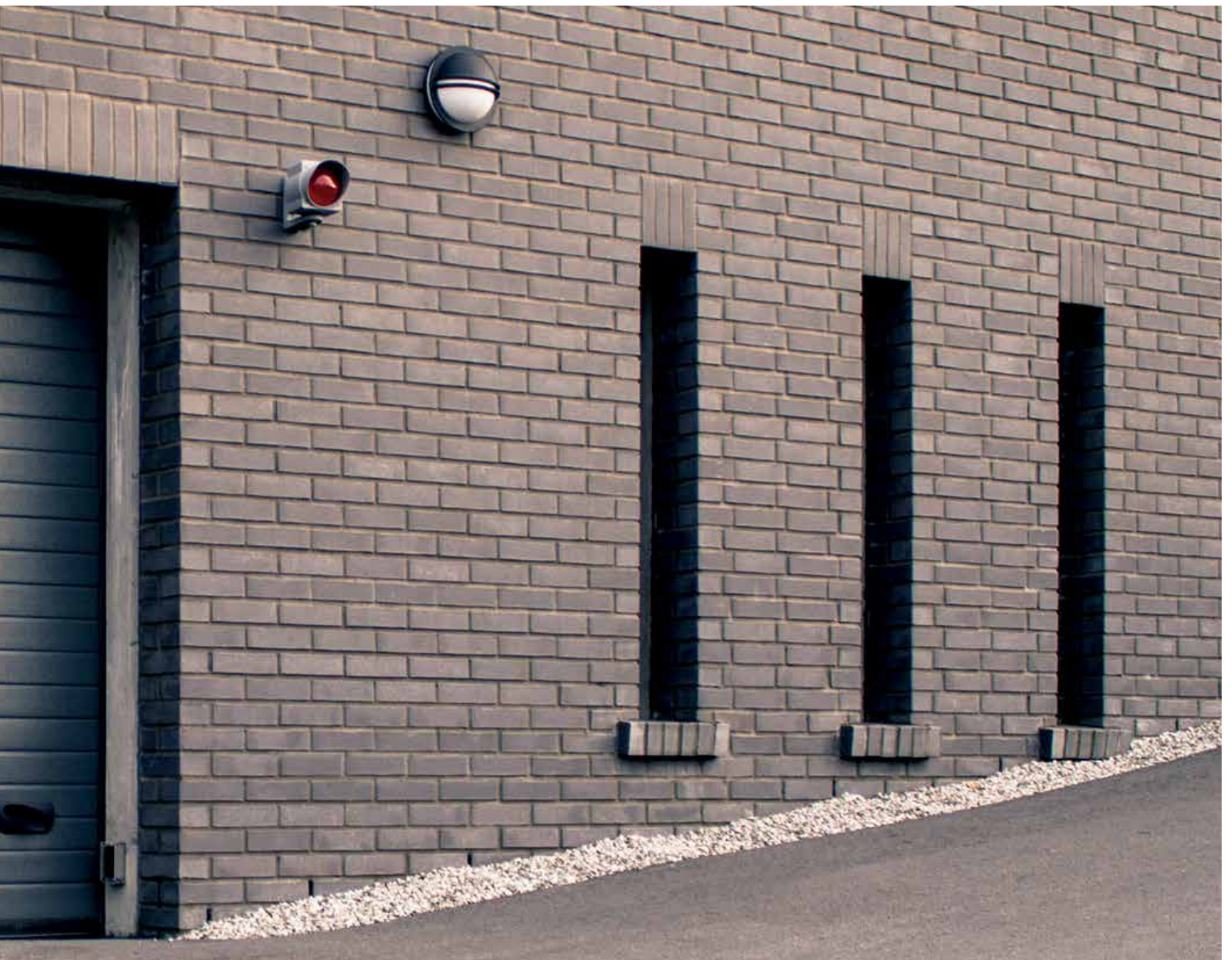



Applicazioni

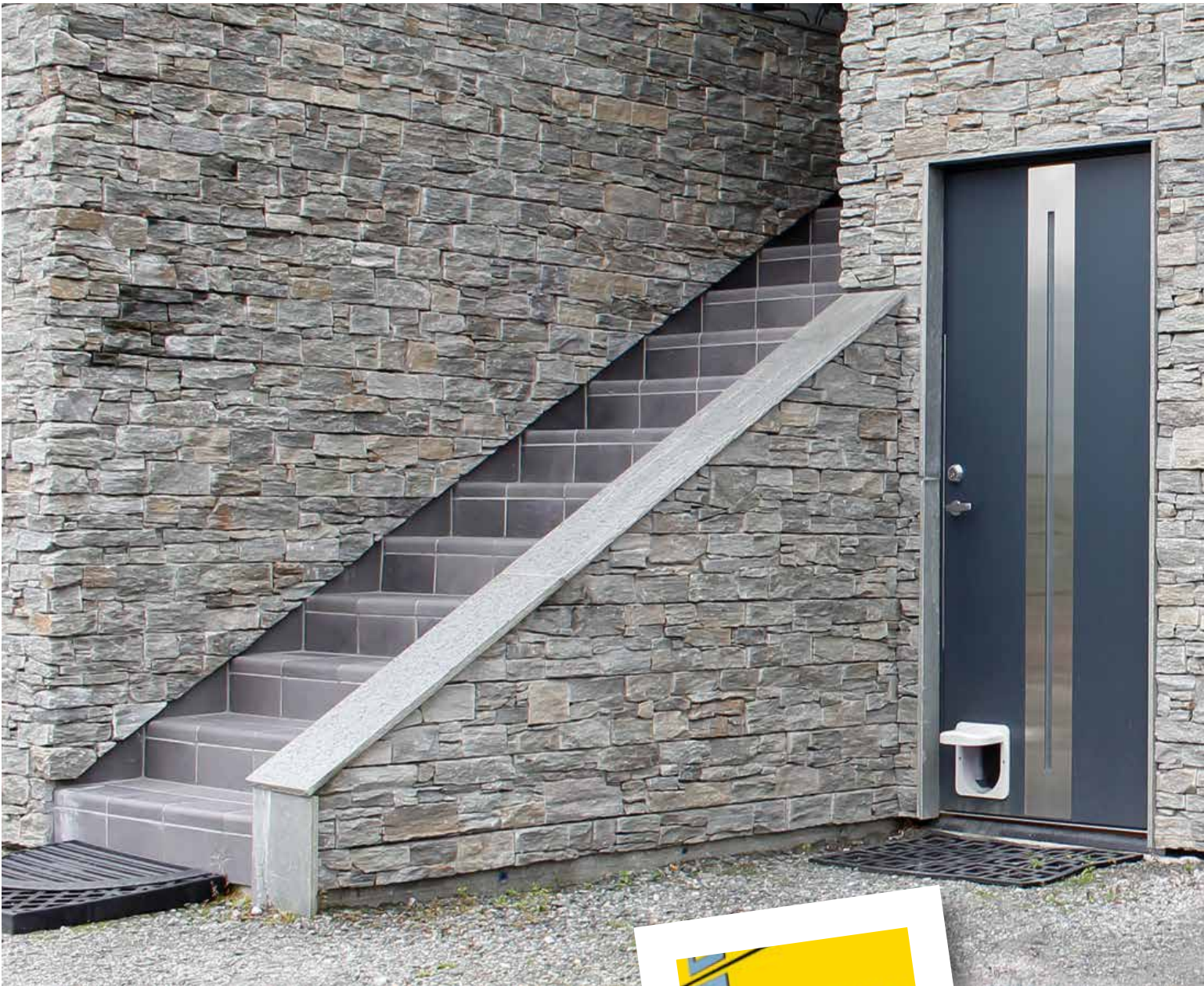

Ti offriamo svariate possibilità di personalizzare la tua porta. Applicazioni speciali studiate assieme a te. Libera la tua creatività e realizza la porta dei tuoi sogni. Al resto ci pensiamo noi. Le applicazioni sono realizzate in acciaio inox liscio o spazzolato tagliato al laser e possono essere verniciate in ogni tinta della tabella RAL.



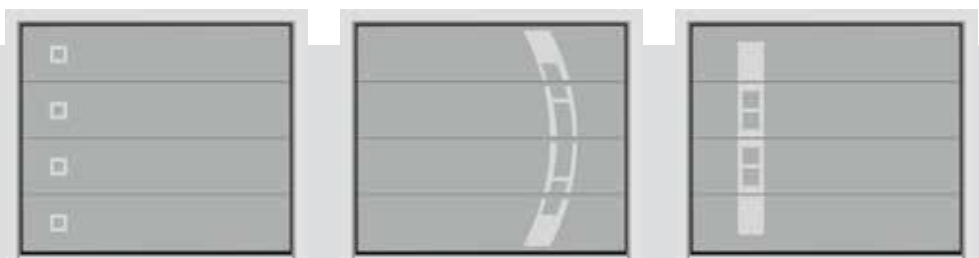
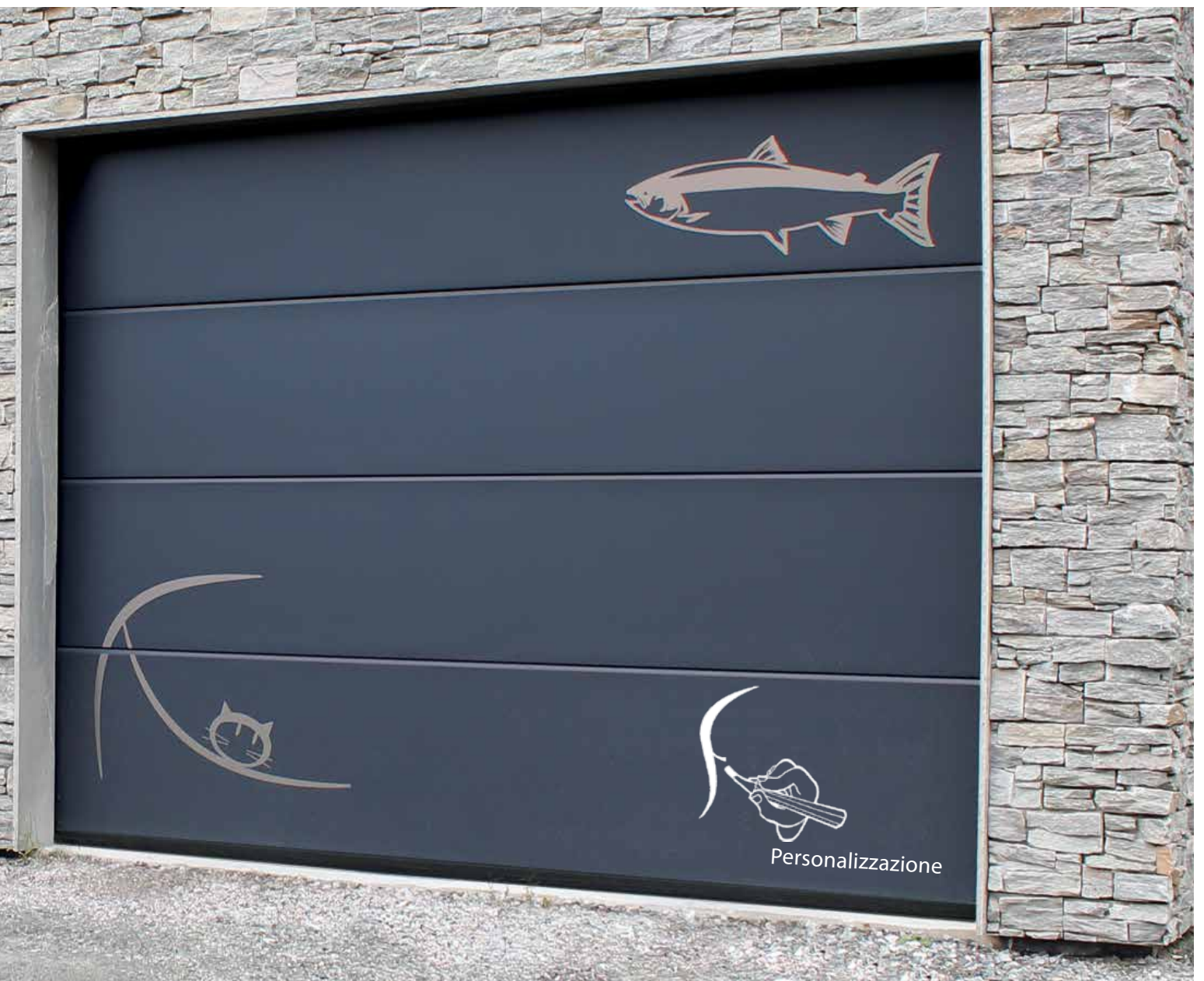



Sezioni Finestrate

Le nostre porte possono essere fornite con sezioni finestrate con telaio in alluminio naturale, verniciato RAL o simil legno Golden Oak.

Le sezioni vetrate possono essere fornite in acrilico trasparente, opaco, effetto ghiaccio o colorato.

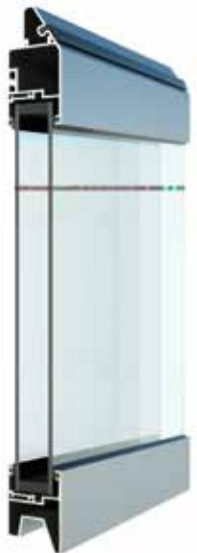

trasparente

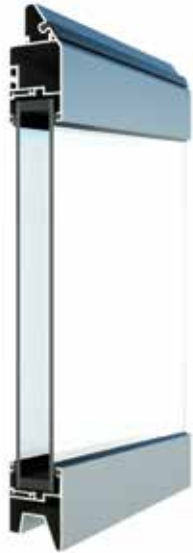

opaco

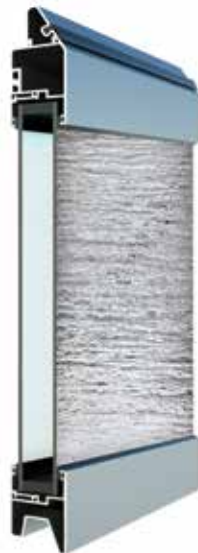

"effetto ghiaccio"



colorato

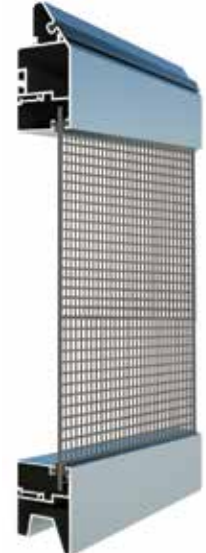

lamiera microforata
zincata



Finestra in acciaio spazzolato

Dona un look moderno e contemporaneo alla tua porta scegliendo le finestre all'interno della nostra vasta gamma.



GRANDE 315 x 315 mm
MEDIA 235 x 235 mm
PICCOLA 155 x 155 mm



GRANDE 315 mm
MEDIA 235 mm
PICCOLA 155 mm

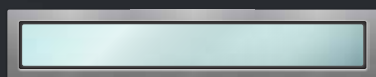

805 x 155 mm



Finestre In PVC Doppio Acrilico

Svariati tipi di finestre ed inserti per rendere unica la tua porta o combinarla allo stile della tua casa. I profili interni ed esterni possono essere verniciati nella tinta desiderata.





1



Sistema guide sicuro ed affidabile. Tutti i cavi e le pulegge sono protette.

2

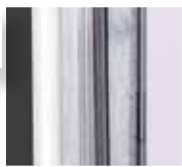

Le guarnizioni laterali fungono da efficace isolamento termico e da protezione contro il pizzicamento delle dita.

3



4



5



6



7



Meccanica dell'R40

La porta sezionale R40 è stata studiata per assicurare un montaggio semplice e confortevole. L'architrave richiesto è estremamente ridotto ed è la soluzione ideale per il mono-garage sia delle nuove abitazioni che per le ristrutturazioni dai soffitti bassi. Realizzata su misura e pre-assemblata in fabbrica è la soluzione ideale per una rapida installazione.

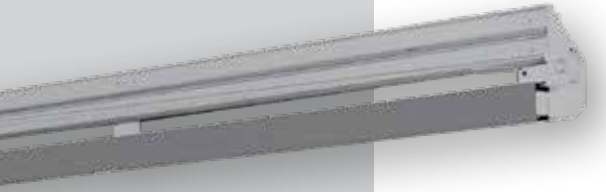

R40-TM



R40-SM



R40-UM

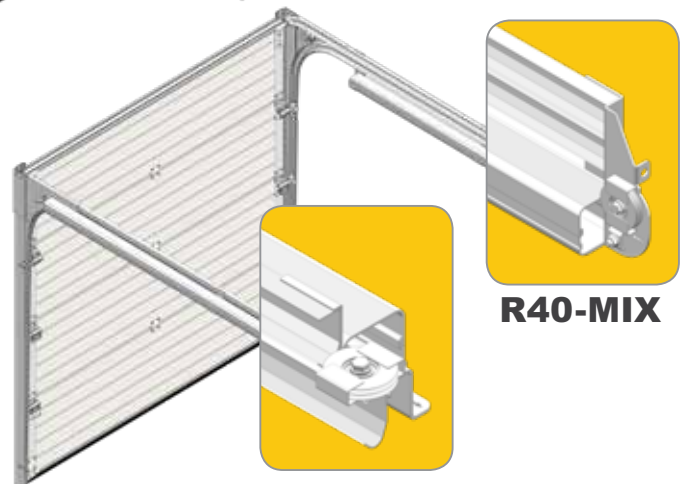

R40-MIX

Le molle a trazione sono pre-assemblate in fabbrica. Possono essere montate sotto, sopra o di lato alla guida orizzontale. Sono carterizzate per assicurare un montaggio ed un utilizzo sicuro della porta. Per la massima sicurezza in caso di rottura accidentale della molla, ogni porta è dotata di 4 sistemi molla-cavo.

Ruote in nylon con cuscinetti integrati. Il massimo della durata e dell'affidabilità.

Protezione antischiacciamento delle dita durante le fasi di movimentazione della porta.

Solide cerniere laterali con carrello regolabile. Il massimo dell'affidabilità e della sicurezza della porta.

Maniglia di sollevamento integrata nella piastra inferiore della porta per assicurare la movimentazione della stessa in caso di mancanza di corrente.



1



Meccanica sicura ed affidabile. Materiale di prima qualità e spessori generosi.

2



Guarnizioni di chiusura perimetrali assicurano una perfetta chiusura verso l'esterno.

3



4



5



6



7



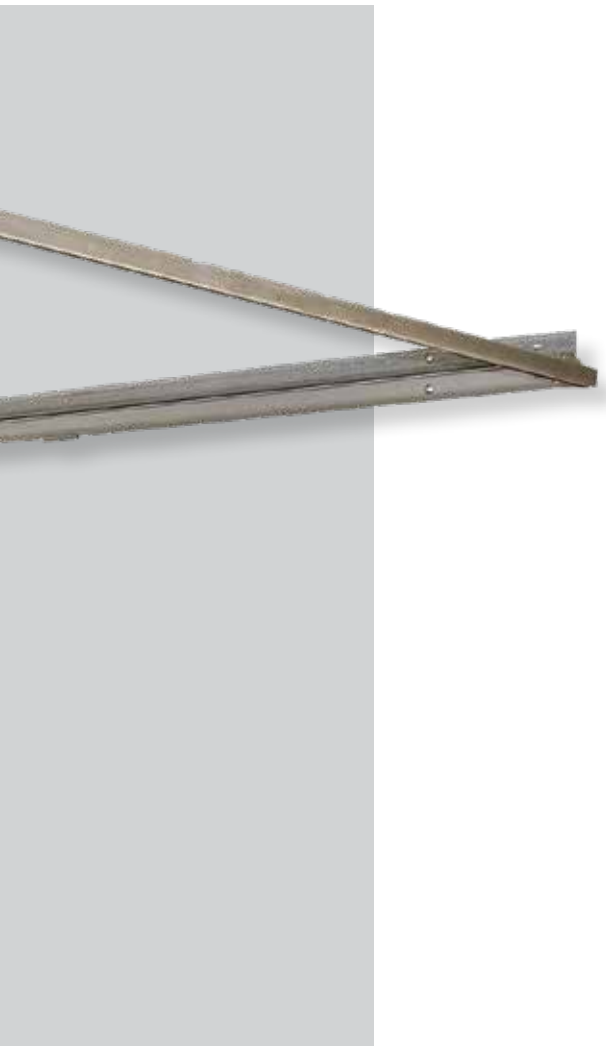

Meccanica TL

La meccanica per porte sezionali residenziali tradizionali è sviluppata secondo le più severe condizioni d'uso grazie anche alle esperienze maturate in campo industriale. L'esperienza produttiva decennale ha portato all'affinamento costruttivo di ogni singolo dettaglio. Tutto questo lo chiamiamo Qualità Intelligente ed è sempre in continuo sviluppo.



Molle a torsione. Ogni porta è fornita con sistema di sicurezza antirottura molle per ogni singola molla del sistema.



Le ruote con cuscinetti a sfera e parti d'attrito in nylon assicurano affidabilità e silenziosità di funzionamento.



Protezione antipizzicamento. I pannelli anti pizzicamento prevengono la possibilità di eventuali lesioni durante il funzionamento della porta.



Le robuste cerniere laterali assicurano uno scorrimento ottimale e scongiurano il pericolo di deragliamento.



Pratica maniglia interna di sollevamento utile in caso di mancanza di corrente.

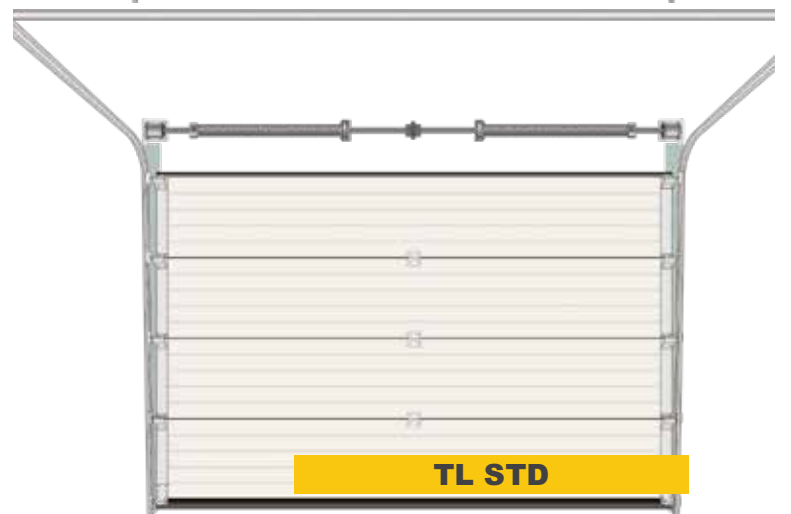



Sistema Guide bianco o verniciato RAL a scelta.



Veletta in alluminio:
120 mm; 180 mm.



Carter copri spalletta 105x45 mm coordinato col manto della porta.



Telaio in alluminio montaggio in luce con veletta da 120 mm (per porte R40 e LHR RM)
Telaio in alluminio montaggio in luce con veletta da 180 mm (per porte LHR FM)



Telaio in alluminio con cornici integrate



Accessori

MANIGLIE E SERRATURE RYTERNA



SERRATURA STANDARD



SERRATURA A POMOLO



MANIGLIA A POMOLO



SERRATURA IN ACCIAIO INOX



CASSETTA LETTERE INTEGRATA



CASSETTA LETTERE INTEGRATA



MANIGLIA STANDARD



GRIGLIA DI VENTILAZIONE



PORTINA PASSAGGIO ANIMALI





Porta Sezionale A Scorrimento Laterale



Verniciature simil-RAL
disponibili a richiesta.



RAL 9016
legno



RAL 9016
stucco



RAL 9016
liscio



Tipologia di manto:

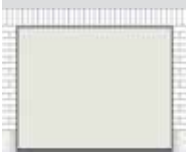

DOGA PICCOLA



DOGA MEDIA



DOGA INTERA

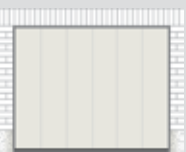

SLICK



MICRORIB



MACRORIB



CASSETTONE



FV

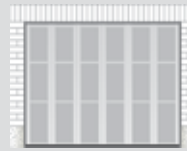

FV-CON RIEMPIMENTO
IN ALLUMINIO

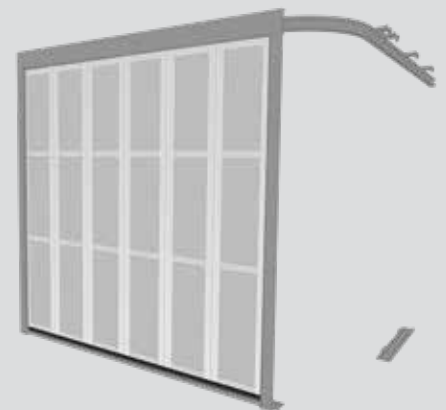

- Look elegante, praticità d'uso ed alta affidabilità nel tempo.
- Vasto assortimento di manti disponibili.
- Apertura parziale per passaggio pedonale (anche con motori predisposti).

- Sistema guide in alluminio dalla bassa manutenzione. Carrelli di elevata qualità.
- Coibentazione da 40 mm e spazzolini su tutto il perimetro per un elevato isolamento termico.
- Guida inferiore dal basso profilo che non richiede opere murarie.



Meccanica SSD

Porta sezionale a scorrimento laterale





4

1



Motore per azionamento elettrico.

2



Serratura per porta in versione manuale.

3



Spazzolini lungo tutto il perimetro della porta.

4



Ruote a cuscinetti su robusti carrelli e solide guide in alluminio per porte fino a 30 metri quadri.

5



Guida inferiore dal basso profilo installabile su pavimento esistente. Bassa manutenzione.

Pannelli rivestiti con listelli di larice



Porta da 11 metri rivestita



Realizzazioni speciali a richiesta



